

PLUG IN TYPE TERMINAL BLOCK — ETB43 SERIES

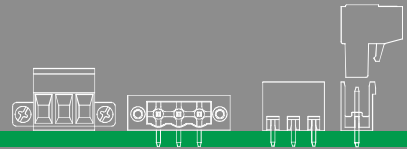

SOCKET TYPE

PITCH=5.08mm

FEATURES

- Special wire protector design to ensure reliable wire clamping
- Be capable of clamping a wide range of wire diameters
- The Male connector of plug using a twin leaf phosphor bronze contact mates with the Female socket
- The Female socket is mounted and soldered to the P.C.B.
- Good for insertion & withdrawal
- UL 94V-0 grade fire retardant engineering plastic used for the housing

SPECIFICATIONS

- Pitch 5.08mm
- No. of pole per block 2P to 16P
- Rating 10 Amp, 300 VAC
- Housing PA66
- Terminals Tin plated over Copper Alloy
- Operating temperature -30°C~+105°C
(Includes temperature rise limit)
- UL Approval 300V, 10A
- CUL Approval 300V, 10A
- TUV Approval 250V, -30°C~+110°C, 15A Max., 0.2 to 2.5mm²



PART NUMBERING SYSTEM

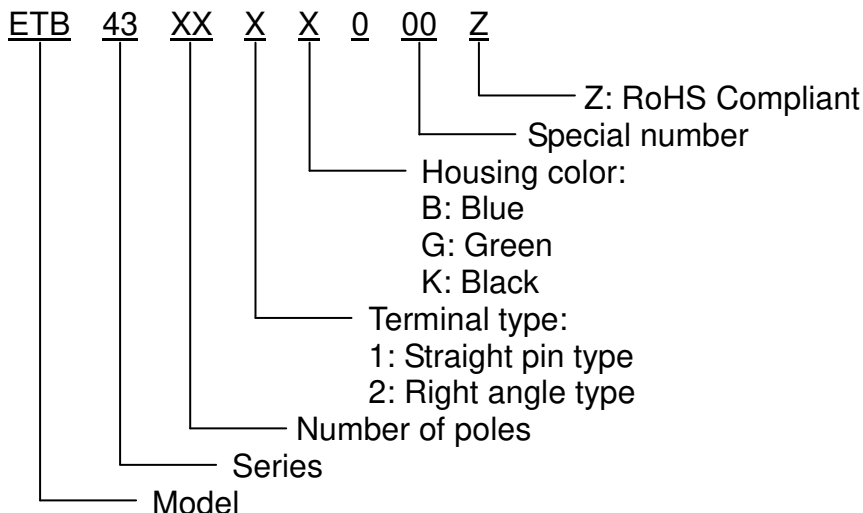

PLUG IN TYPE TERMINAL BLOCK – ETB43 SERIES

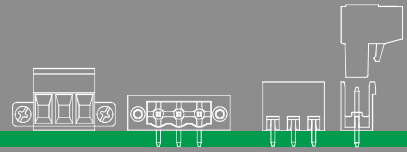

DRAWING

ETB43**1

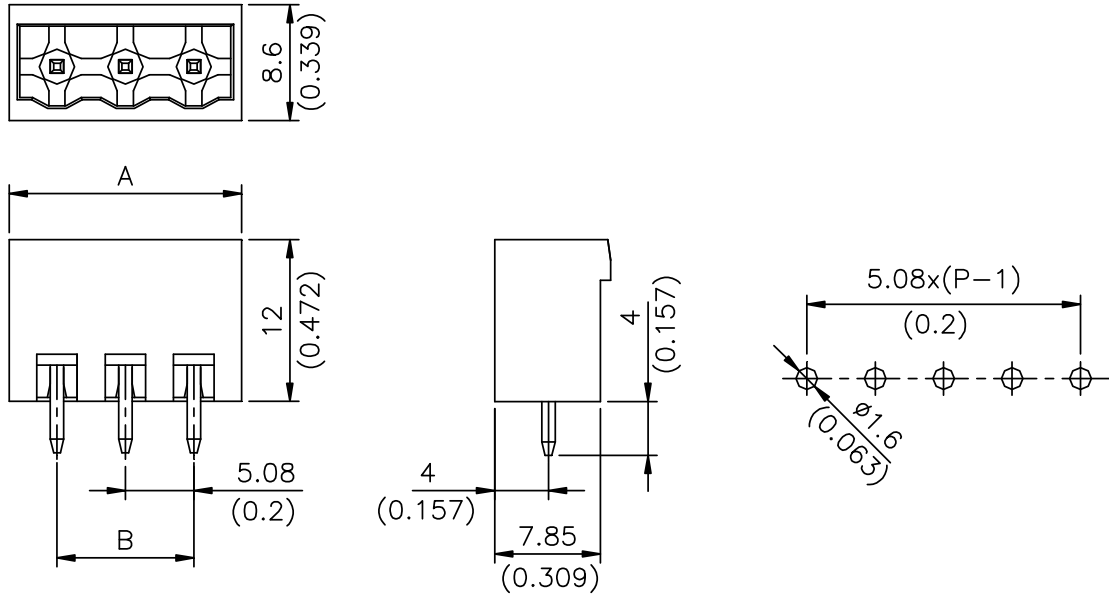

ETB43**2

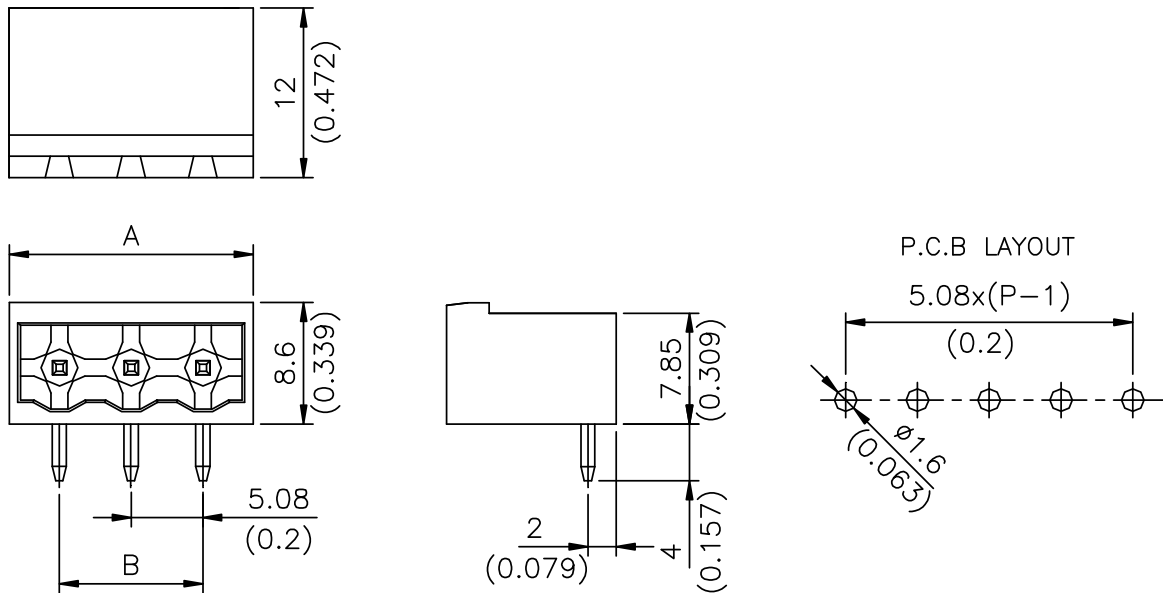

POLE DIM.	2	3	4	5	6	7	8	9	10	11	12	13	14	15	16
A	12.18 (0.480)	17.26 (0.680)	22.34 (0.880)	27.42 (1.080)	32.50 (1.280)	37.58 (1.480)	42.66 (1.680)	47.74 (1.880)	52.82 (2.080)	57.90 (2.280)	62.98 (2.480)	68.06 (2.680)	73.14 (2.880)	78.22 (3.080)	83.30 (3.280)
B	5.08 (0.200)	10.16 (0.400)	15.24 (0.600)	20.32 (0.800)	25.40 (1.000)	30.48 (1.200)	35.56 (1.400)	40.64 (1.600)	45.72 (1.800)	50.80 (2.000)	55.88 (2.200)	60.96 (2.400)	66.04 (2.600)	71.12 (2.800)	76.20 (3.000)

PLUG IN TYPE TERMINAL BLOCK — ETB43 SERIES

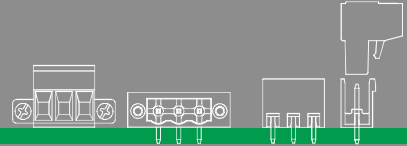

STACKABLE TYPE

PITCH=5.08mm

FEATURES

- Special wire protector design to ensure reliable wire clamping
- Be capable of clamping a wide range of wire diameters
- The Male connector of plug using a twin leaf phosphor bronze contact mates with the Female socket
- The Female socket is mounted and soldered to the P.C.B.
- Good for insertion & withdrawal
- UL 94V-0 grade fire retardant engineering plastic used for the housing

SPECIFICATIONS

- Pitch 5.08mm
- No. of pole per block 2P to 16P
- Rating 10 Amp, 300 VAC
- Housing PA66
- Terminals Tin plated over Phosphor bronze
- Operating temperature -30°C~+105°C
(includes temperature rise limit)
- UL Approval 300V, 10A
- CUL Approval 300V, 10A
- TUV Approval 250V, 15A Max.



PART NUMBERING SYSTEM

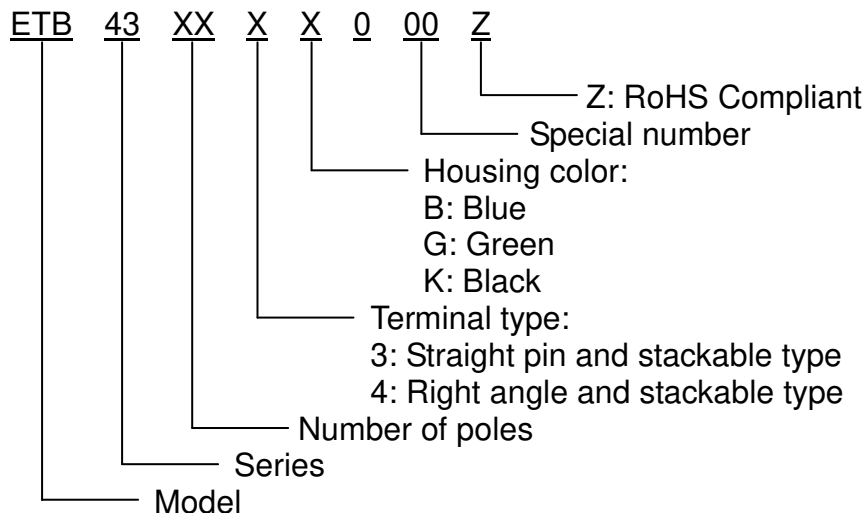

PLUG IN TYPE TERMINAL BLOCK – ETB43 SERIES

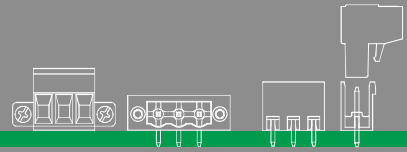

DRAWING

ETB43**3

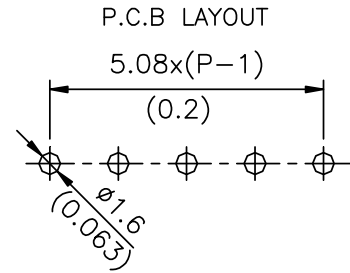
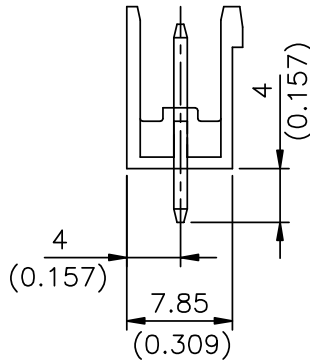
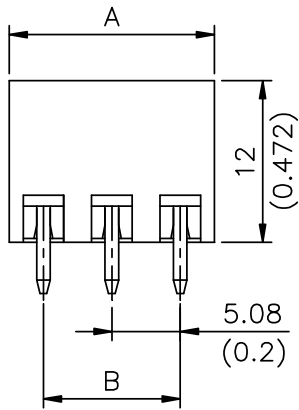
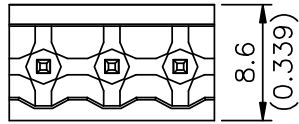

ETB43**4

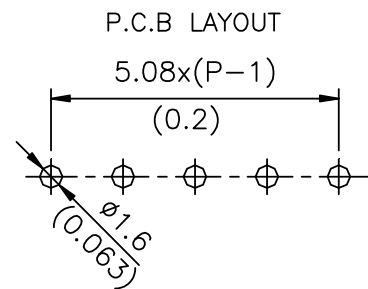
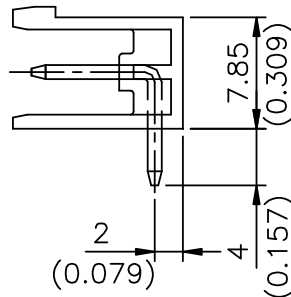
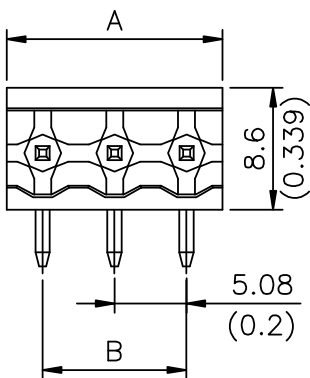
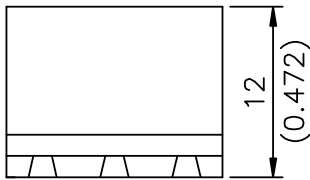

POLE DIM.	2	3	4	5	6	7	8	9	10	11	12	13	14	15	16
A	10.16 (0.400)	15.24 (0.600)	20.32 (0.800)	25.40 (1.000)	30.48 (1.200)	35.56 (1.400)	40.64 (1.600)	45.72 (1.800)	50.80 (2.000)	55.88 (2.200)	60.96 (2.400)	66.04 (2.600)	71.12 (2.800)	76.20 (3.000)	81.28 (3.200)
B	5.08 (0.200)	10.16 (0.400)	15.24 (0.600)	20.32 (0.800)	25.40 (1.000)	30.48 (1.200)	35.56 (1.400)	40.64 (1.600)	45.72 (1.800)	50.80 (2.000)	55.88 (2.200)	60.96 (2.400)	66.04 (2.600)	71.12 (2.800)	76.20 (3.000)